

The Koi Solution Kit



This manual is for the Dankoff Solar The Koi Solution Kit which uses the SunCentric surface pump for small orchard irrigation.



Cables

Fittings and Hardware

SunCentric Pump

Disconnect Panel

Photovoltaic (solar) Panels

Panel Rack



Contents

- 1. WARNINGS 3
- 2. WHAT'S IN THE BOX(ES) 4
- 3. INSTALLATION REQUIREMENTS..... 5
- 4. MECHANICAL (PLUMBING) SYSTEM HOOKUP 6
- 5. SOLAR ARRAY WIRING 11
- 6. STARTING THE SYSTEM..... 15
- 7. TROUBLESHOOTING 16
- 8. MAINTENANCE 18
- 9. PUMP REPAIRS 19



1. WARNINGS

Please review the following warnings. These are listed for both personal safety and the safety of the products. Disregarding or ignoring these warnings can result in **SERIOUS INJURY** and/or **VOID THE WARRANTY**. If this system is being installed without a licensed pump installer, an electrician or knowledge of electrical circuits is **HIGHLY** recommended.

If any questions or concerns regarding these warnings should arise, please contact your local Dankoff Solar dealer or Dankoff Solar Technical Support at 1(505) 395-2491. Dankoff Solar Pumps and/or its parent company, Solar Power & Pump Co, is **NOT LIABLE** for any **DAMAGE** or **INJURY**.

- The system should be installed and serviced by qualified personnel only. All electrical codes should be observed. Make **ABSOLUTELY CERTAIN** all power sources are disconnected prior to wiring.
- Extreme heat can damage the pump. Protect the pump from sunlight or other heat sources.
- Install proper system grounding for safety and lightning protection. Proper grounding can significantly reduce the chance of extreme damage. See Section 4.4 Grounding and Lightning Protection
- Under-sizing the wires or failing to install a fuse or circuit breaker can cause a Fire Hazard and cause damage to the motor. Follow all guidelines in Section 4
- Do not touch solar panel or pump wires together to test for a spark.
- Do not run the pump dry.
- The use of a filter is required. For details, see Section 3 Installation Requirements

2. WHAT'S IN THE BOX(ES)

(1) SunCentric Surface Pump



(1) Disconnect switch and (2) mounting brackets



(1) PV Mounting Rack and (4) PV panels

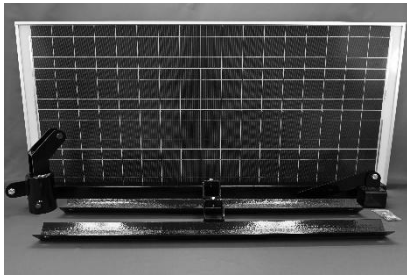

(4) 3' PV Cables and (1) 10' PV Cable



(1) Footvalve strainer, (3) Hose Adapters, & (3) Clamps



(1) Grounding wire, bolts, and clip

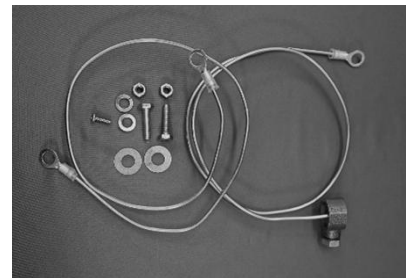

(2) Branch Plug Connectors



3. INSTALLATION REQUIREMENTS

Kit Overview

The Koi Solution Kit is designed for plug-and-play installation and comes complete with all the necessary hardware and fittings to do so. Because each installation is different a few locally purchased components are required to complete installation:

- Hoses – Dankoff Solar recommends flexible suction and discharge hoses, and The Koi comes with the necessary fittings and clamps for this type of hose. Inlet hose size is 1 ¼” and outlet hose size is 1”. Simply ask for ‘suction hose’ at your local hardware supply store to purchase the lengths you will need for your installation
- Rack Mounting Pole – The Panel Rack in The Koi Solution Kit includes a gimble that will accept a 3” mounting pole. Dankoff Solar recommends using Schedule 80 pipe, installed 36” below the frost line using Quickrete, with a minimum of 36” above the ground to accept the rack. PV’s must not be shaded or blocked at any point during the day to get the stated performance.
- Grounding Rod – Because of the ready availability and to reduce the shipping weight of The Koi Solution Kit, all of the components to properly ground the system are supplied, with the exception of the grounding rod itself, which can be purchased at any hardware or electrical supply store.
- Pump House/Cover – Because every installation environment is different, the Solution Kit does not include a generic pump house to shield the pump from the elements, since the pump can be installed in a variety of ways. Dankoff Solar recommends that the SunCentric pump be shielded from the elements to get the most out of its 20 year life, and there are many available options that can be purchased locally.

Some ideas include: a curved piece of sheet metal with open ends (the cover should be twice as long as the pump); a metal barrel cut in half the long way and placed over the pump; any weatherproof box inverted over the pump; a dog house set it over the pump with the pipes passing through the doorway.

Non-submersible pumps

Do not submerge pump or motor in water, or allow water to drip on the motor.

Filtration requirements

SunCentric Pumps are somewhat dirt tolerant and can be run from many clean water sources without filtration. However, to prevent possible large debris contamination and to help keep the pump primed, a Dankoff Solar Fine Intake Strainer Foot Valve (PN – 11044) has been provided with the proper fittings.

Pump must not run dry

Water is the lubricant for the pump. If the pump runs completely dry, it will overheat and fail. If pumping from a tank, cistern or any water source that can run low accidentally, we recommend using a float switch.

A float switch (PN – 11004, pump down switch) placed in the supply tank closes when the tank water supply is at a high level. When the water level drops to a low level, the switch will open and remove power from the pump motor. This has not been supplied with The Koi Solution Kit, as it will only be used in a limited number of Customer applications.

4. MECHANICAL SYSTEM HOOKUP

Mount the Pump

The pump may be mounted horizontally or vertically. If mounted vertically, suspend from a rope and face the pump head downward. Rigid mounting is not required in most installations. Observe the pump and ensure that it does not overstress or loosen pipes as it starts. In non-battery systems like The Koi Solution Kit, starting is gradual and the pump does not torque with the start. Mounting the pump directly to a wall or wood floor will increase the noise heard in that structure.

Take every precaution to prevent the pump from freezing. The forged brass pump head will survive most light freezes, but a hard freeze may damage it. If the pump is insulated for freeze protection, keep the motor exposed to prevent overheating.

Once you have determined where the pump will be mounted and covered, use the flanges on the pump body to mount it to a stable location if desired. Follow the chart below in determining the proper location and orientation of the pump.

It is important to minimize Suction Lift. Suction lift refers to the pressure (negative pressure) on the suction (inlet) side of the pump. As the vertical distance from the pump inlet to water increases, the suction lift pressure also increases. The practical suction/intake pipe limit for any pump is 20 vertical feet to water at sea level (subtract 1 ft. for every 1000 ft. of elevation). Limiting the pipe length to 2 to 3 feet will allow the pump to run quietly and more reliably. Placing the pump downhill from the water source also helps to minimize suction lift.

Pump and Pipe Positions -- Yes or No?

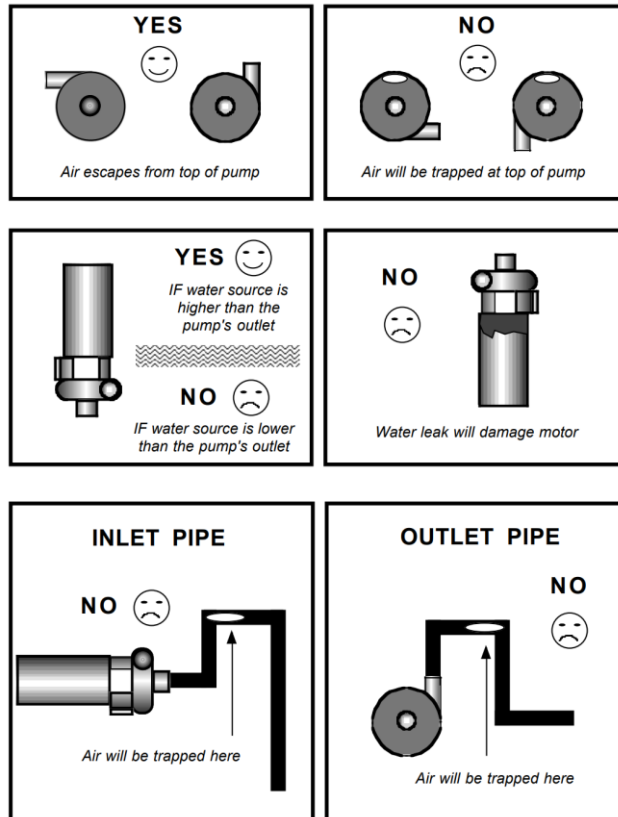

Connect the Hoses

Inlet Hose – Keep the inlet hose lengths as short as possible. Do not use thin-wall hose or soft tubing on the pump's intake, as it may collapse under suction and restrict the flow. Hose reinforced with steel braid is recommended. If you elect to use polyethylene pipe (black flexible polypipe) be aware that it can be prone to slight leakage at the fittings so ensure all connections are watertight.

The inlet must not be obstructed or restricted by undersized pipe, excessive suction lift, or a clogged filter. Excessive suction at the pump inlet causes cavitation (formation of vapor bubbles). A cavitating SunCentric will not pump any fluid.

Avoid humps in the intake line that can trap air pockets and block the flow. Ensure the inlet hose is free of leaks.

The supplied foot valve should be installed at the end of the inlet hose at the water intake source. This valve is important to install because it allows water to flow in one direction only, helping to keep the pump primed when not running. It is required in any case where the pump is located higher than the low-water level in the source.

Outlet Hose – The length of the outlet hose is not as critical as the inlet hose length, though the SunCentric pump is not intended to pressurize the outlet side. Maximum performance is achieved when the SunCentric can open flow to flood the intended irrigation area.

Mount the PV's to the Rack

Dankoff Solar recommends that you attached the PV's to the rack hardware first, then lift the entire unit onto the Rack Mounting Pole.

In The Koi Solution Kit the PV's will be mounted 2 PV's on top, 2 PV on bottom, touching in the middle.

To do so, first lay 2 PV's face down on a soft surface (cardboard works well), and align them together along their long edge, with cables at the same end. This will be the 'bottom' of the solar array. The photo below is an illustration but may not be the same PV's in your kit. The installation principle is the same, however.



The PV Rack comes with four 'ribs' and a 'spine' that will connect to the gimble. Lay one rib across all four holes at the top of this pair of PV's and use the supplied hardware to attach the rib to the PV's. Note the orientation of the rib in relation to the top of the array, since the spine will pass through it.

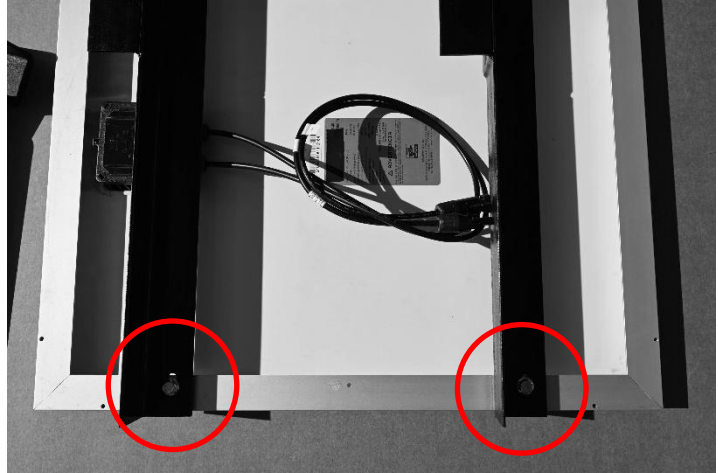

Attach the other rib to the lower holes in the same orientation. Once both ribs have been attached to the PV's, set this pair aside and repeat this operation with the remaining pair of PV's and ribs.

Once each PV pair is mounted to the ribs, set them face down with the top edge of the lower set touching the bottom edge of the upper set. Now insert the spine through the lower ribs (#1 and #2) and up through rib #3.

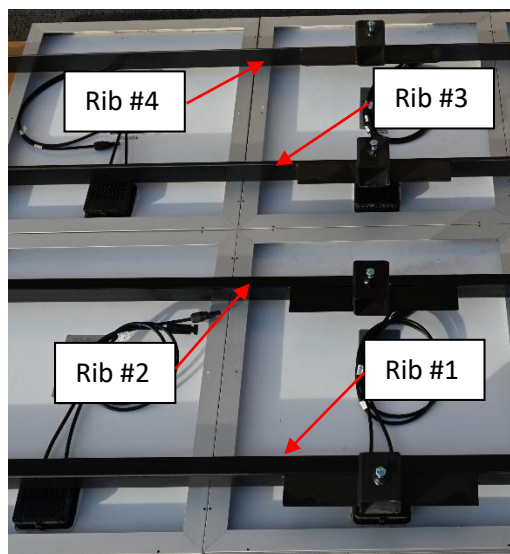

Before inserting the spine through rib #4, insert the square pivot over the spine. Now continue passing the spine through rib #4. Center the hole in the spine between ribs #2 and #3 and then tighten all of the rib bolts. Note the orientation of hole in the photo below:

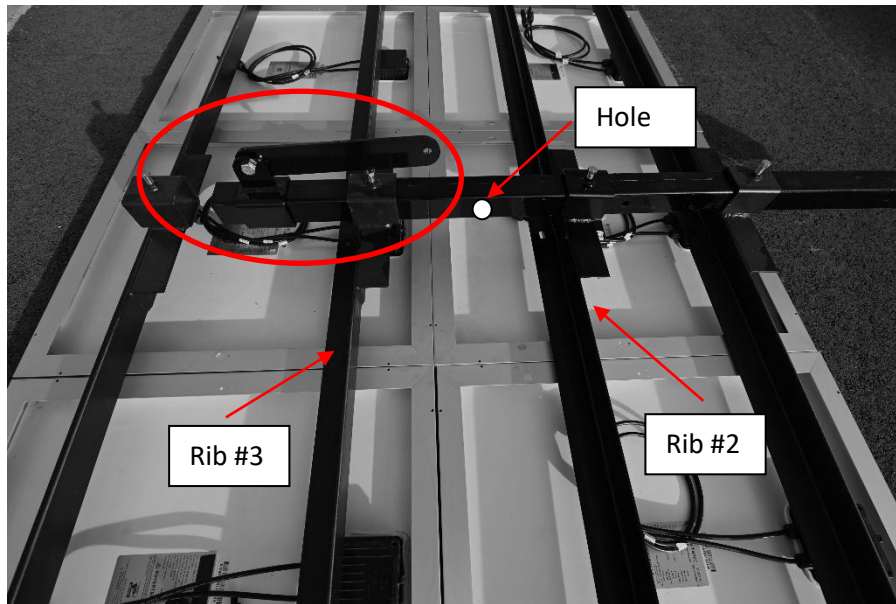

Now attach the gimble to through the hole on the spine, with the gimble opening facing the bottom of the array, as shown in the photo below:

Take the square pivot and connect it to the flange on the gimble, as shown in the photo below. Until the entire array is mounted on the pole, leave the bolts loosely tightened.

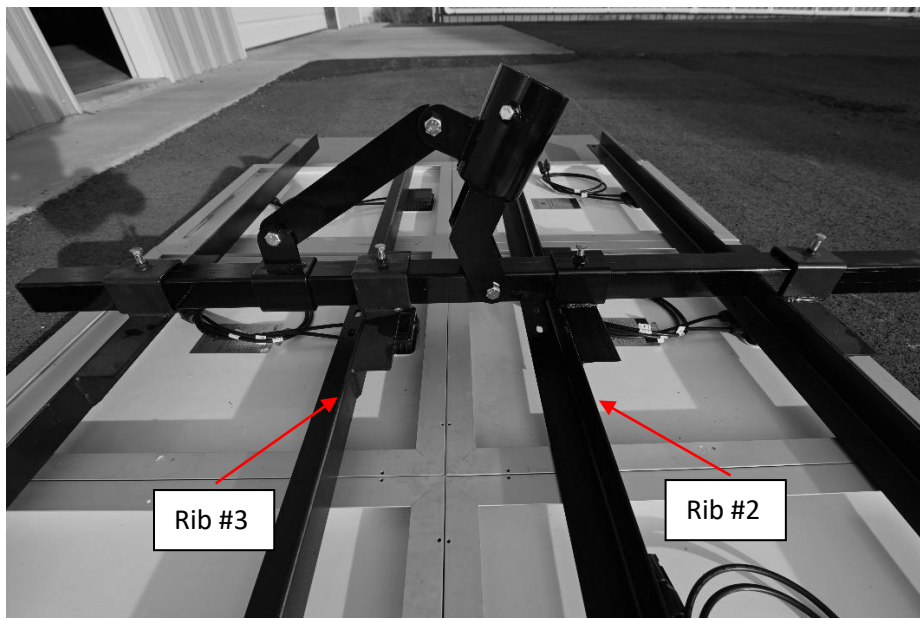

Now the entire array can be lifted onto the mounting pole. The position of the square pivot can now be adjusted so that the face of the array is tilted (from horizontal) to match the chart below. To maximize sunlight hours the array can be tilted two times per year in the summer and winter. Else, a year-round tilt is sufficient for most applications.

Location	Latitude	Summer Tilt (-15°)	Winter Tilt (+15°)	Year-Round Tilt
Southern Canada	50°	35°	65°	50°
Upper Third of US	45°	30°	60°	45°
Middle Third of US	40°	25°	55°	40°
Lower Third of US	35°	20°	50°	35°
Central Mexico	20°	5°	35°	20°

Now face the array to the south and tighten the three bolts to secure the gimble to the mounting pole. Tighten the remaining bolts left loose up to the point.

5. SOLAR ARRAY WIRING

Warning – The photovoltaic array generates hazardous voltages. A 48 Volt (nominal) array can generate nearly 100 volts when disconnected from load.

To prevent shock hazard while working on array wiring, be certain the breaker inside the disconnect is in the “OFF” position or cover the array to shade it.

Attention – Wiring the panels in the wrong configuration (series or parallel) can damage the pump. Be certain of the wiring configuration (See Figure below: Solar Panel Wiring Diagram for examples) prior to connecting the array. Additionally, it is recommended to cover or shade the panels when connecting them to the controller or pump. This prevents electrical discharge from damaging the equipment. Any damage caused by disregarding these warnings will NOT be covered under the warranty.

Connecting the Solar Array

Now that the PV Array is mounted on the rack and in place it is time to make the electrical connections. All of the connections on The Koi Solution Kit use standard PV quick connects. The figure below shows the basic wiring:

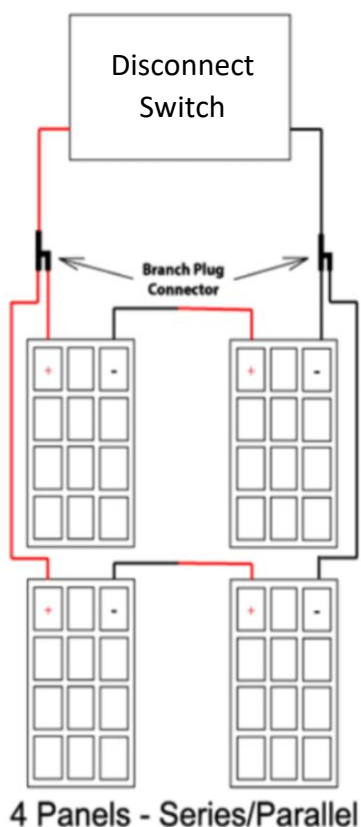

In practice the connections are more simple than the diagram illustrates. First, connect the two PV's together by connecting a 'male' wire from one panel to the 'female' wire of the other panel, shown by the red line in the photo below.

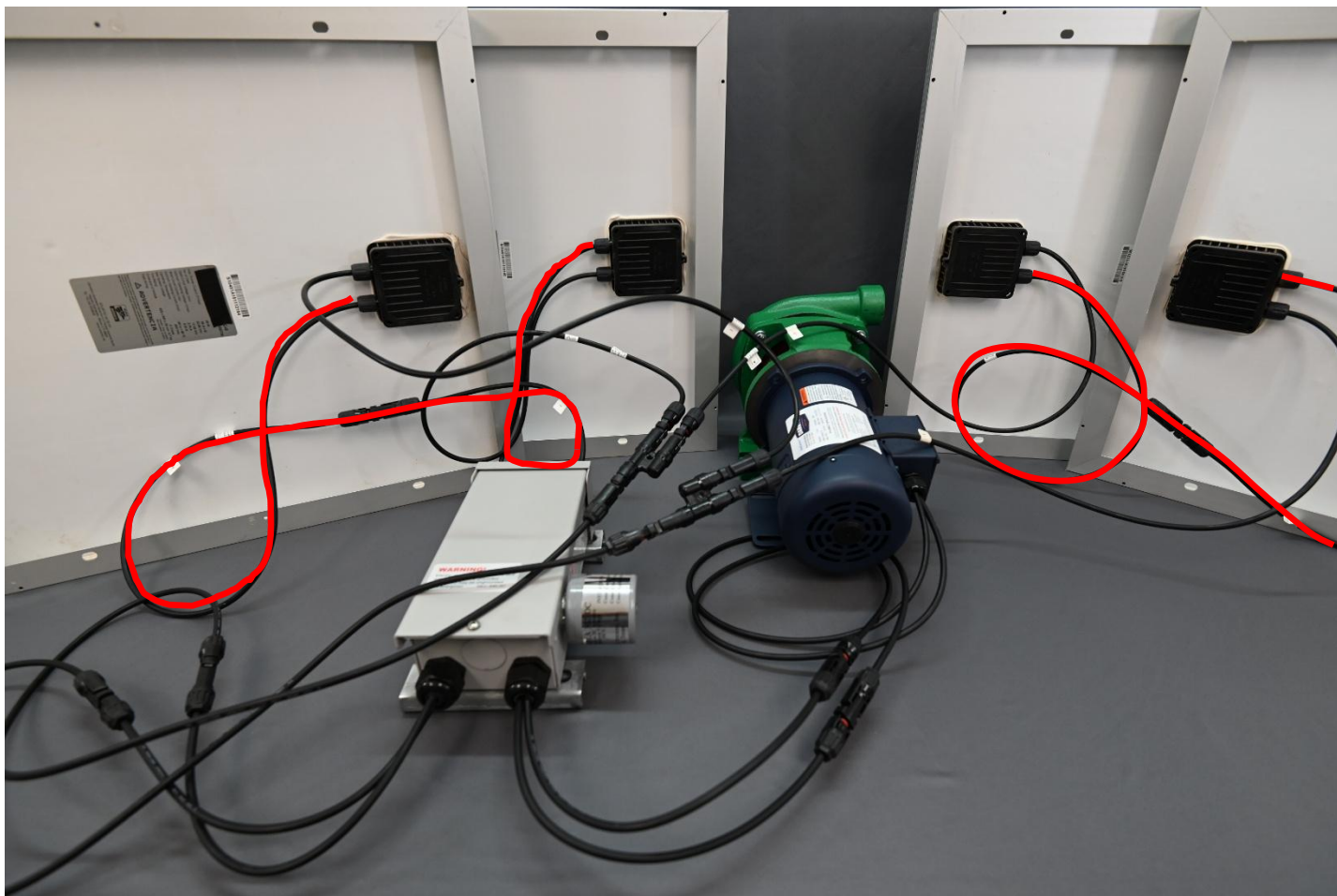

Connect the remaining 'male' wire (one from each PV) to the branch plug connector, then connect a 3' cable to the left side of the disconnect box as shown below by the blue line.



Connect the remaining 'female' wires to the other branch plug connector and use another 3' cable to connect the combiner to the remaining open wire on the left side of the disconnect, shown by the orange line below.



Complete the wire connections from the disconnect box to the pump using the supplied 10' cable. It is important to note a solid 'click' sound when connecting cables to be certain they do not come loose over time.

Grounding the System

To properly ground the system drive the grounding stake until just 6" remains above ground. Connect the supplied copper cable to the end of the stake and thread it around the rack pole up to the disconnect switch. Use the supplied bolts to ground the disconnect box and then connect to the PV array directly, as shown in the Solar Panel Wiring Diagram above.

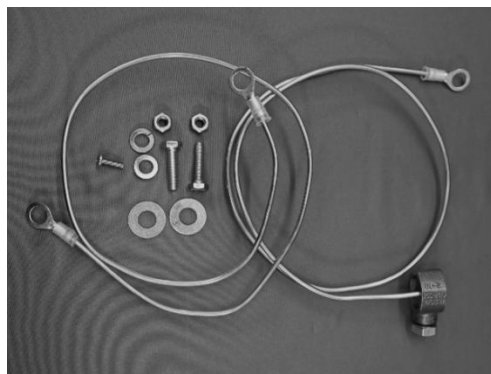

6. STARTING THE SYSTEM

Before You Begin

The breaker inside the disconnect switch should remain 'off' until the system has been primed and there is enough sunlight to run the system.

Prime the System with Water

Priming a pump means filling its intake pipe completely with water and must be done if the pump is mounted higher than the water source.

Prime the pump by removing the inlet hose at the pump intake and pour water into the opening until it is completely full. The foot valve keeps the pump primed by preventing water from back flowing into the water source. Replace the inlet hose onto the pump intake.

Power on the System

Flip the breaker inside the disconnect switch to the 'on' position. If there is enough sunlight, the pump should start moving water within a few seconds. As sunlight fades the pump will spin more slowly until it stops. The reverse will happen as the sun rises and as soon as there is enough current the pump will begin to spin. There is no need to turn the pump on/off each day.

7. TROUBLESHOOTING

Motor Doesn't Turn On

1. Check fuse or breaker and any control or wiring devices in line.
2. Motor starts when hit or tapped lightly - Sticking brushes or other brush problem. Inspect the brushes.
3. Remove the rear cover of motor to check connections. Check for voltage present at motor. If voltage is present, see next entry.

Pump Spins But Doesn't Pump Water

1. Check direction of rotation. If not clockwise (viewed from brass front-end) reverse motor polarity.
2. Check Prime - Open and re-prime the pump. Check all the fittings, a pinhole leak in the suction pipe will cause loss of prime. Inspect, pressure-test, clean or replace the foot valve. Ensure no debris are trapped in the foot valve.
3. Polyethylene Pipe Fittings – Ensure fittings are tight. Gently heat with torch or hot water and retighten hose clamp with a wrench. Replace stripped clamps. Use stainless steel clamps.

Noisy Pump – A noisy pump indicates cavitation which can cause rapid pump wear.

Unsteady buzzing sound – Indicates leak in suction line allowing air to enter. Try the following:

1. Check for bubbles in inline (transparent) filter or air in outlet water.
2. Check prime. Open and re-prime the pump. Check all the fittings, a pinhole leak in the suction pipe will cause loss of prime. Inspect, pressure-test, clean or replace the foot valve. Ensure no debris are trapped in the foot valve.
3. Some inline filters may have a red push-button valve to release pressure for maintenance. If the filter is incorrectly installed (too high above the water source) the suction may pull the valve open and introduce air. To prevent this, seal the push-button with silicone sealant or epoxy, or replace the button with a bolt and nut, sealed with silicon and tightened down.
4. If no source of air leakage is present, water may have high concentrations of dissolved gases which release as bubbles in the suction pipe. Reduce suction lift if possible. Install an air chamber in the intake line, with a valve on top. Pour water in to replace air when problem reappears.

Filter clogs frequently

1. Intake too close to the bottom of well, stream, tank etc. Raise it as high as practical to reduce intake of dirt.
2. Improve the development of the water source. Channel clean water into a settling tank and clean the tank periodically.
3. Install a larger filter or plumb two filters parallel to each other.

Low Flow Rate / Pump Turns Fast and Draws Low Current – Pump is worn out from dirt, rust or other abrasive particles in water, or from cavitation, from running dry or age. Replace pump head.

Low Flow Rate / Pump Turns Slowly and Draws High Current (may run hot and/or blow fuses) / Pump is Difficult to Turn

1. Excessive vertical lift, beyond the system's capacity: Exchange the pump head for a model with correct lift specifications or increase the size of solar array.
2. Misalignment of coupling shaft - Check rubber shaft coupler for damage.
3. Mineral Deposits - Turn shaft with two fingers. If difficult to turn, use vinegar to dissolve the mineral deposits in the plumbing. Remove pipes from the pump and allow solution to circulate through the pump by turning it backwards. Replace or rebuild the pump if deposits cannot be removed.

Pump Will Not Turn – The shaft coupler can't be turned by hand. The fuse is blowing or breaker is tripping.

1. After a period of disuse or storage, the impeller may lock up. Using pliers on the shaft coupler, gently rotate the pump backwards (counterclockwise).
2. Debris is jammed in the pump. Disconnect the plumbing, pour water into outlet, and run pump in reverse (by reversing polarity). Watch for debris exiting inlet. Damage to the pump is likely.

Pump Emits Crunching Sounds, Black Material in Outlet – Internal parts are broken, either by debris in pump, severe freezing or external shock.

Water Damage, Motor Submerged or Dripped On – Inspect brushes and commutator. If in poor condition, the motor may need a rebuild (new bearings). In extreme cases the motor must be replaced. Contact Dankoff Solar support. Correct the cause of damage.

Rusty/Noisy Bearings

1. Pump head - Steel ball bearings are visible at pump head shaft. Rust caused by water drip or submersion. Pump head must be rebuilt to replace the bearing.
2. Motor - Replace with double sealed "R8" bearing (front) and "R6" (rear). These are common bearings available from automotive or electric motor suppliers, or directly from Dankoff Solar. A puller tool or a press is needed for removal.

Pump Frozen by Low Temperature / Blown fuse or circuit breaker tripped – Allow the pump to thaw. Observe performance. If the motor is damaged, replace or rebuild. Check all plumbing for damage and leaks and protect from future freezing.

Motor Brushes – Motor brushes are carbon rods that make electrical contact with the spinning copper "commutator" on the motor shaft. The two brushes are accessible via the cover at the rear of motor. Brushes must be unbound and slide in and out freely, a spring pushes the brush in as it wears.

Brushes must be at least 3/8" long (longer on motor larger than 5" diameter). They generally last about 5 years unless the motor has been wet inside (see "WATER DAMAGE").

1. Worn Brushes – Replacement brush part numbers are located on the pump label. Call your dealer or Dankoff Solar for replacements.
2. Sticking Brushes - Inspect inside each brush holder with a flashlight. Clean if corroded or dirty. If brushes still don't slide in/out freely, very lightly sand the long sides of each brush.
3. Brush Springs Weak – If the spring looks discolored the motor may have overheated from a severe overload and lack of fuse protection. Replace the brushes. If the motor does not start, it must be replaced.
4. Broken Brush Holder - Replace the brush holder (contact Dankoff Solar).
5. Commutator - The commutator is visible through the brush holders. The commutator may be damaged by poor brush contact, overheating or water damage. The wear surface should be smooth, with a uniform brown color. Commutator damage may require resurfacing on a lathe. Contact Dankoff Solar to perform these repairs.

8. MAINTENANCE

Shaft Seals - Seals may last for a few years, but if the water contains abrasive silt, the seals will wear faster. Seals will be quickly ruined if the pump runs dry. You can purchase spare seals from your Dankoff Solar dealer and **MUST** be installed correctly. The smooth white ceramic face must face outward, away from the motor. The part with the spring presses over the shaft. The all-black end must contact the white ceramic face. The metal and rubber end faces away from the motor.

Seal and Gasket Kits

If last digit of the pump model number is 1, 2, 3, or 4 – order Dankoff Solar item #37690

If last digit of the pump model number is 5 or 6 – order Dankoff Solar item #37691

Seal and Gasket Kits for High Temperature pumps

If last digit of the pump model number is 1, 2, 3, or 4 – order Dankoff Solar item #37695

If last digit of the pump model number is 5 or 6 – order Dankoff Solar item #37696

The seal is an industry-standard pump seal for 5/8" shaft. In case of emergency, you may be able to obtain one from a local pump supplier or electrical repair shop. If the paper pump gasket is damaged, a new one can be cut from thick paper. Manila file folders works fine.

Before pressing the seal parts into place, use your finger to wipe a small amount of oil or grease onto the cast iron, rubber and shaft surfaces. This will make installation and service much easier. **DO NOT** get any lubricant onto the mating white and black faces of the seal. Always replace **BOTH** parts of the seal (the black part and the black & white part)

Pump Head – The pump head is maintenance-free. Do not remove its front plate or otherwise tamper with it. The pump head is not user repairable. It is easy to disassemble, but difficult to reassemble without special tools.

Motor Brushes – Motor Brushes: Typical brush life peak hours = working voltage X 800 / 3rd digit of model number. EXAMPLE: PV-Direct curve #60 is Model 7526 working at 30V. Typical brush life = $30 \times 800 / 2 = 12,000$ peak hours. This represents about 5-8 years of service. Your result may differ. New Brushes measure 1.25 inches (31 cm) in length. You can measure wear after a period of time, to predict the brush life. Worn brushes will not effect performance, until they are worn to about 1/2 inch (1 cm.). At that point, to motor will stop as contact is broken. Replacement brushes may be obtained from your dealer or the factory.

Motor Bearings - Ball bearings in the motor are lubricated for life and do not require maintenance. If water enters the motor accidentally, it will damage the bearings. Replacement bearings can be obtained from your Dankoff Solar dealer. Purchase two bearings #6203Z.

9. PUMP REPAIRS

FAILURES

Most failures involve the pump head seal, not the motor, and is indicated by a properly primed pump not able to maintain vacuum and move fluid.

The pump head seal is **user** serviceable, however it is delicate and difficult to re-assemble. Disassembly of the pump head will void the warranty. If the pump head seal has failed, it must be replaced with a new one or sent to Dankoff Solar to be rebuilt.

WARRANTY CLAIMS must include receipt to prove date of purchase.

TO SHIP PUMP TO DANKOFF SOLAR FOR REPAIR:

Please contact your Dankoff Solar dealer to set up a repair and receive an RMA number

(505) 471-2491

FAX (580) 225-1120

Email: support@dankoffsolarpumps.com

Have the MODEL & SERIAL NUMBERS available before initiating a return for repair.

WARRANTY

Dankoff Solar products are warranted to be free from defects in material and workmanship for ONE (1) YEAR from date of purchase.

Failure to provide correct installation, operation, or care for the product, in accordance with instructions, will void the warranty.

Product liability, except where mandated by law, is limited to repair or replacement, at the manufacturer's discretion. No specific claim of merchantability shall be assumed or implied beyond what is printed on the manufacturer's printed literature. No liability shall exist from circumstances arising from the inability to use the product, or its inappropriateness for any specific purpose. It is the user's responsibility to determine the suitability of the product for any particular use.

In all cases, it shall be the responsibility of the customer to insure a safe installation in compliance with local, state and national electrical codes.

ADDITIONAL DANKOFF SOLAR SURFACE PUMPS FOR LIFT AND PRESSURIZING:**SOLAR FORCE PISTON PUMP**

- 5-9 GPM to 230 FEET or to 100 PSI
- Extremely rugged and dirt-tolerant

SOLAR SLOWPUMP

- 0.5-6.2 GPM to 450 FEET
- Capable of pushing through miles of pipeline

SOLAR FLOWLIGHT BOOSTER PUMP

- 2.7-4.5 GPM to 100 FEET
- Provide city water pressure anywhere

SOLARAM SURFACE PUMP

- 3-9 GPM to 960 FEET
- Ask your Dankoff Solar dealer or go to

SUBMERSIBLE PUMPS FOR SURFACE AND DEEP WATER LIFT AND PRESSURIZING:

SunRotor® Submersible Pumps, a division of Solar Power and Pump Co.

www.sunrotor.com

Dankoff Solar and Sunrotor are divisions of Solar Power and Pump Co.

301 West 12th Street

Elk City, OK 73644

(580) 303-4904

(866) 246-7652

Fax (580) 225-1120

www.solarpowerandpump.com